

LA CUSTODIA CB90 PER GUIDA DIN-EN 50022 E' ADATTA A CONTENERE CIRCUITI STAMPATI NEI GUIDA SCHEDE LONGITUDINALI O TRASVERSALI.
SONO UTILIZZABILI CONNETTORI O MORSETTI A VITE FISSI O ESTRAIBILI DI QUALSIASI PASSO.
SI ESEGUONO LAVORAZIONI CUSTOM SU QUALSIASI LATO DEL CONTENITORE (CAVE, FORI, ASOLE).
IL MATERIALE UTILIZZATO E' BLEND PC/ABS IN CLASSE V2-V0 (UL94) NEI COLORI STANDARD VERDE (RAL6017), GRIGIO (RAL 7035) E NERO (RAL7021).

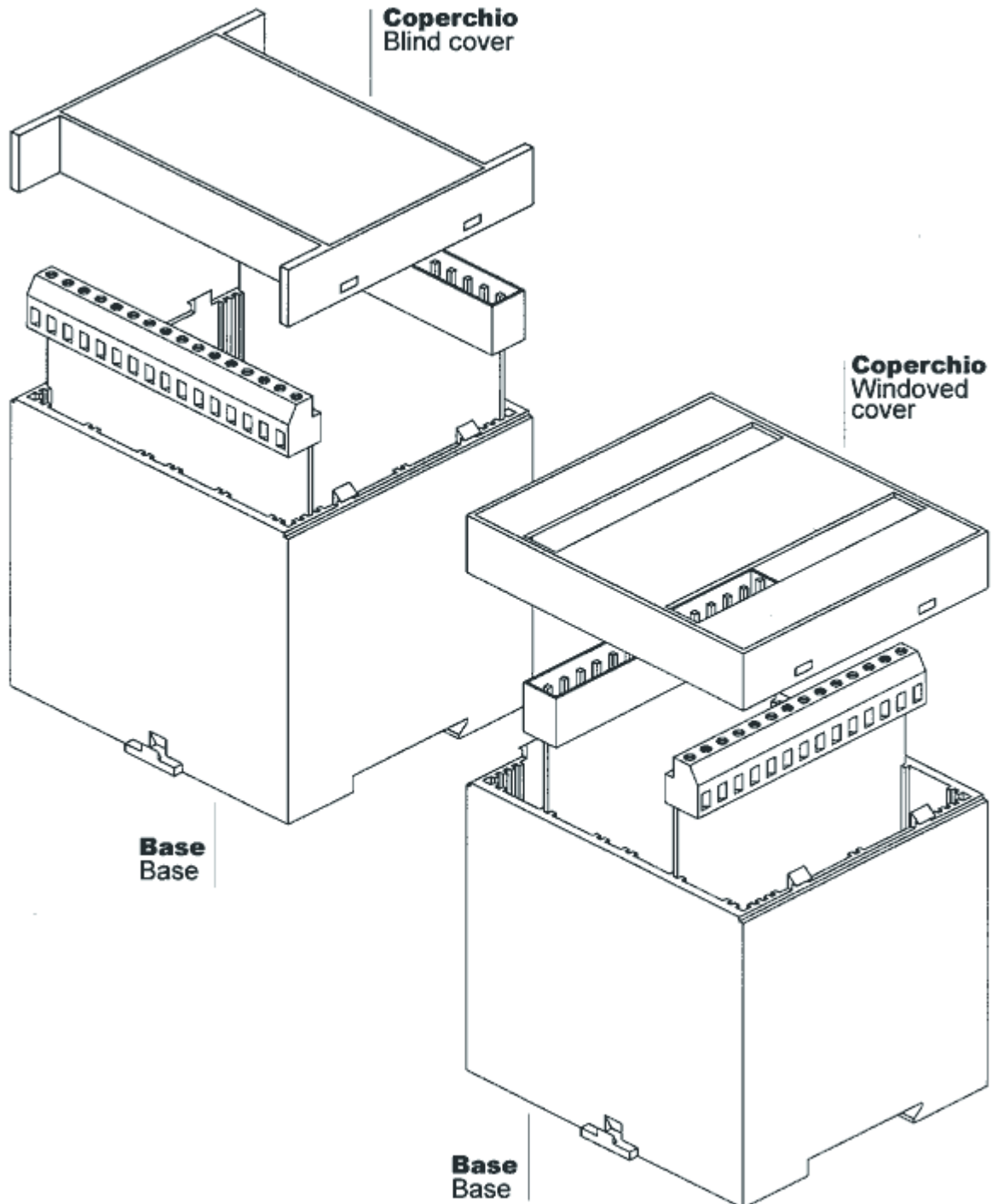

Il contenitore permette il montaggio di più schede longitudinali e trasversali nelle apposite guide. Il coperchio può essere chiuso con più aperture per morsetti e connettori. A richiesta sono disponibili foraturespeciali su ogni lato.

VISTA LATERALE

VISTA SUPERIORE

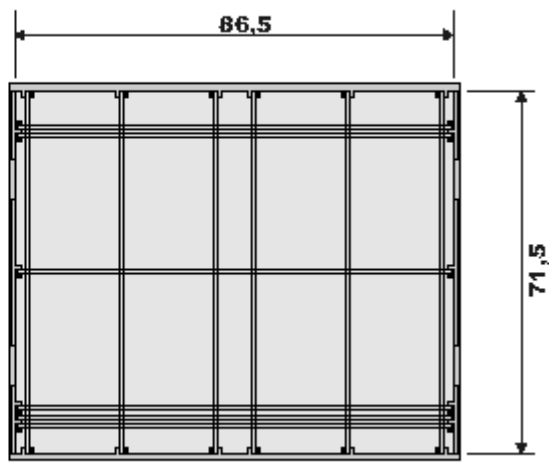
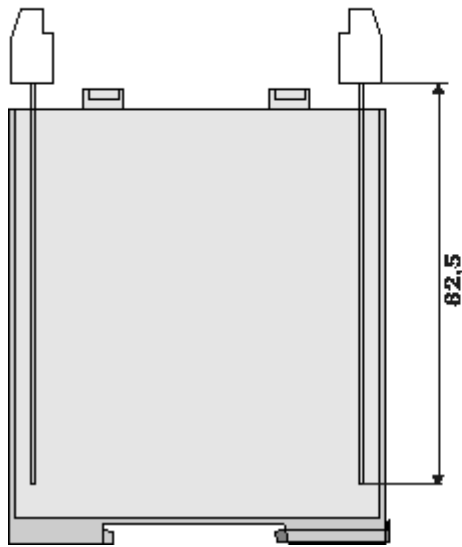
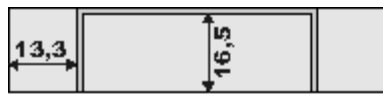

CB 90/A

CB 90/B

CB 90/C

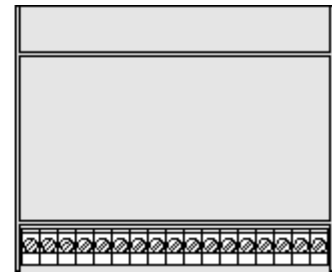
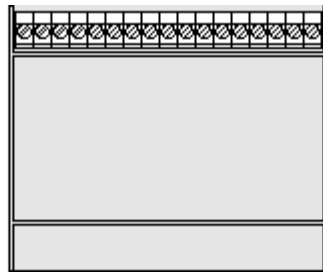
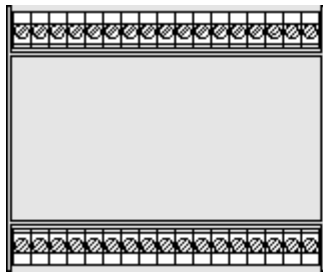

CB 90/D

CB 90/E

CB 90/R

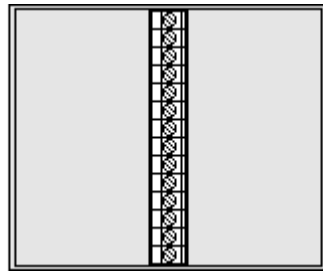
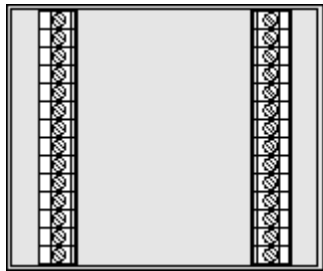

Stampa

Chiudi