

CB90 HOUSING FOR DIN-50022 RAIL CAN HOUSE PRINTED CIRCUITS IN THE LONGITUDINAL OR TRANSVERSAL PCB'S GUIDES.
 SUITABLE TO HOUSE CONNECTORS AND FIXED OR DETACHABLE TERMINALS OF ANY STEP.
 CUSTOM DRILLING ON ANY SIDE (WINDOWS, HOLES AND SLOTS).
 MADE OF BLEND PC/ABS CLASS V2-V0 (UL94) IN GREEN (RAL6017), IN GREY (RAL7035) OR IN BLACK (RAL7021).

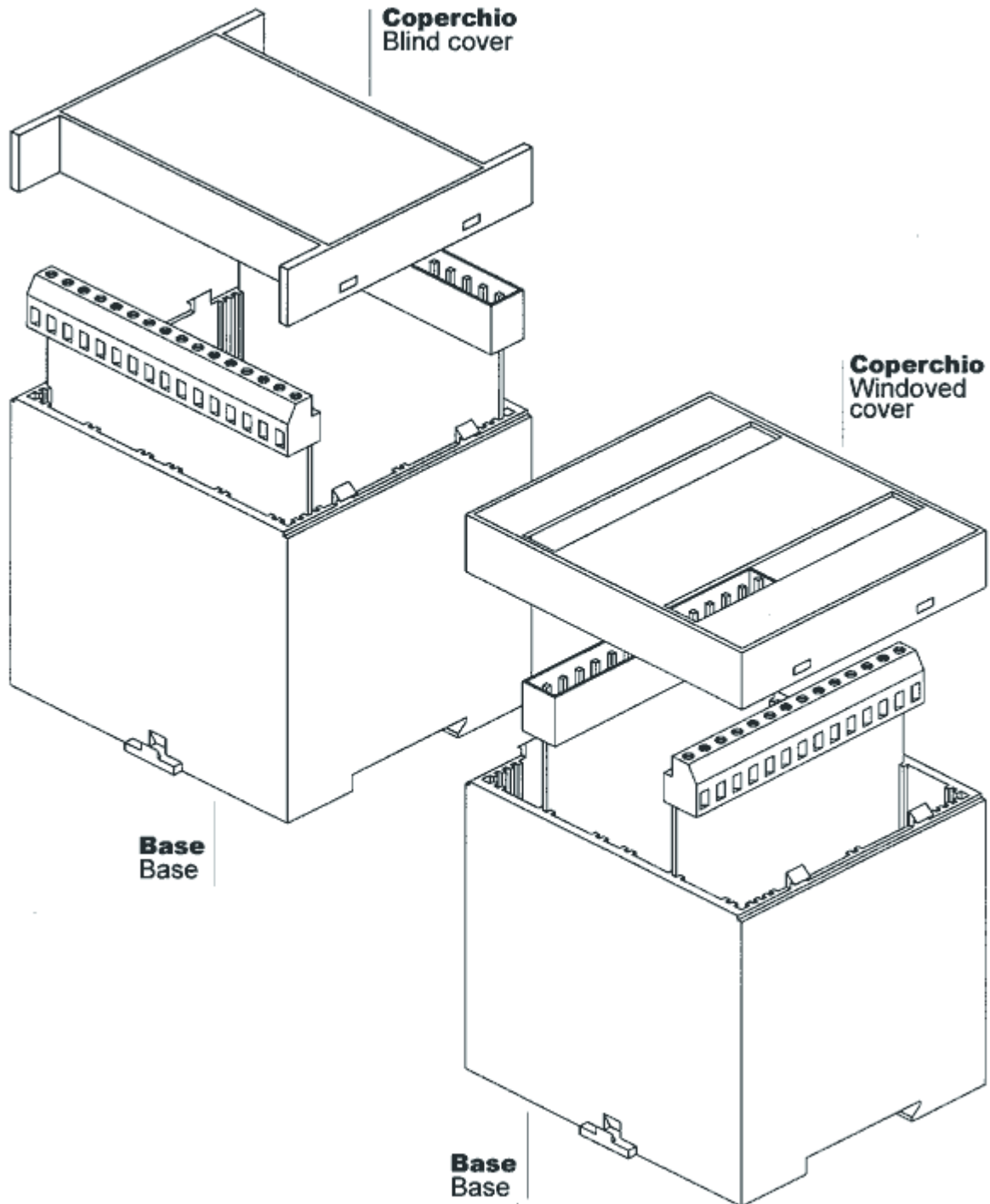

The housing is equipped with longitudinal and transversal guide, in order to accomodate for several PCB's. The cover can be blind or with windows for terminal strips and connectors. On request custom drilling is available on any side.

LATERAL VIEW
UPPER VIEW

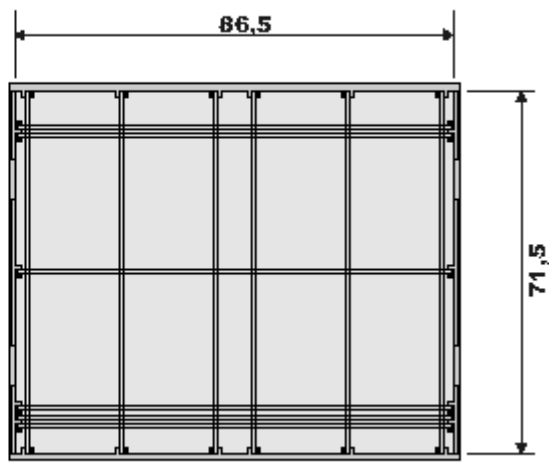
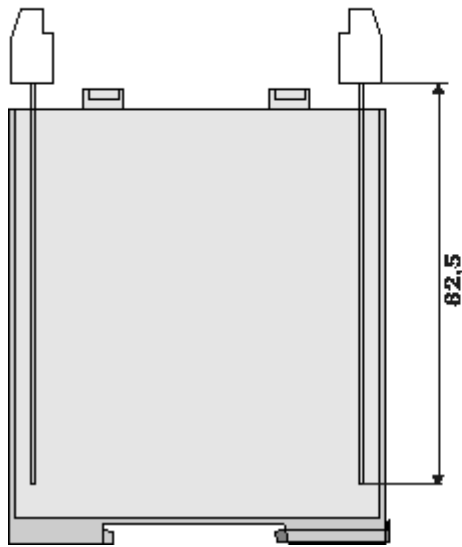
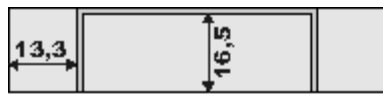

CB 90/A

CB 90/B

CB 90/C

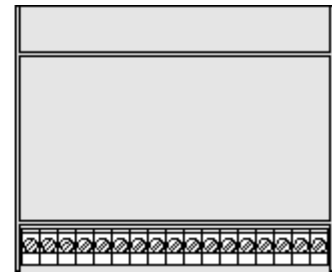
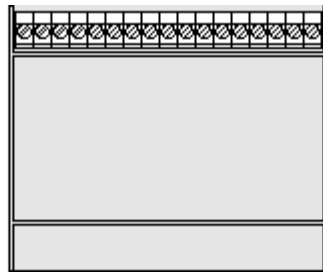
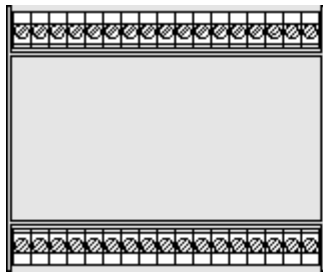

CB 90/D

CB 90/E

CB 90/R

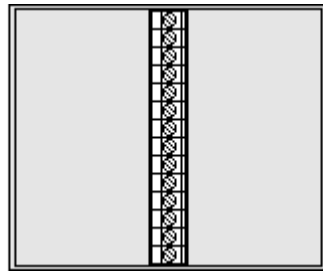
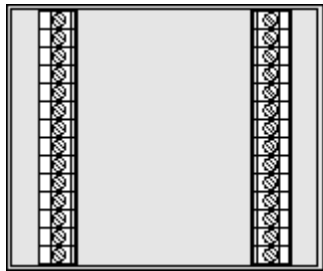

Print

Close